

1 Features

1.1 Hardware

- High-performance, low-noise MEMS IMU
- Integrated low-noise, high-reliability LDO
- Factory calibrated and compensated over the full temperature range of -40 °C to 85 °C, including bias, scale factor, and cross-axis calibration
- Type-C interface with onboard USB-to-UART bridge
- Designed for strong vibration resistance, suitable for vibration-intensive applications
 - Integrated temperature sensor
 - Compact 26 × 24 × 12 mm form factor for easy integration
 - Designed to meet relevant RoHS requirements; halogen-free material options are available. Compliance status and certification availability are subject to the latest official documentation
 - Customization options are available upon request.



1.2 Software

- Adaptive EKF fusion algorithm
- Output data rate up to 1000 Hz, depending on output data type and configuration, with low output latency
- Optimized attitude tracking and vibration suppression for dynamic motion scenarios
- Reduced impact of linear acceleration on attitude estimation under typical operating conditions
- Support for custom binary protocols
- Comprehensive user configuration commands
- Multifunctional GUI for easy operation
- Supports reference examples for ROS1, ROS2, C, MATLAB, Python, Arduino, and more

2 Applications

The HI13 Series is designed for high-performance attitude sensing and complex operating conditions. It is suitable for attitude measurement and control applications involving temperature variation, vibration, and dynamic motion. Typical applications include:

- Service robots
- Humanoid robots
- Low-speed autonomous mobile robots
- Smart agricultural machinery

3 Description

3.1 System Block Diagram

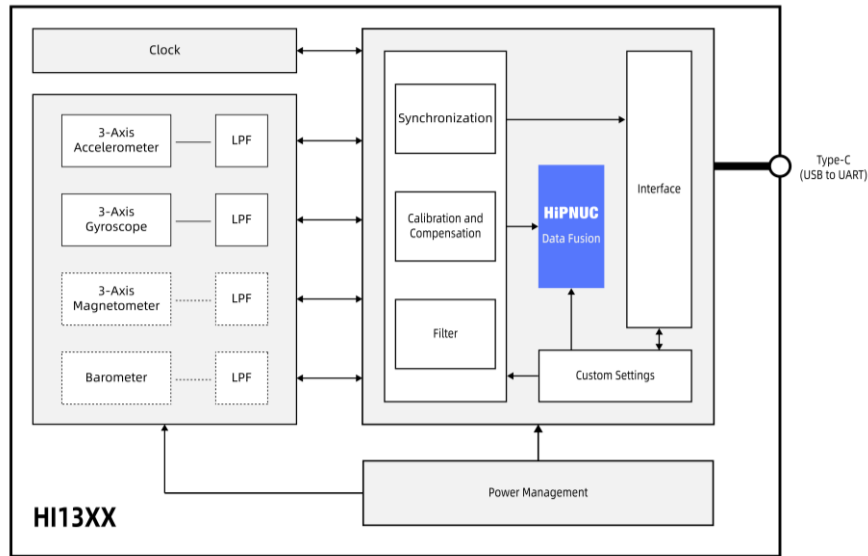

Figure 1: HI13 System Block Diagram

Note 1: Dashed lines indicate functions not supported by some models. See Table 1 for details.

3.2 General Description

The HI13 Series is an IMU/VRU/AHRS sensor module based on a MEMS IMU. It incorporates proprietary adaptive extended Kalman filtering, IMU noise dynamic analysis, and platform motion-state analysis algorithms to provide users with raw inertial data (acceleration, angular rate, magnetic field) as well as computed attitude data (Euler angles, quaternions, etc.). Depending on the model, the HI13 Series supports IMU, VRU, or AHRS functions. Not all models integrate a magnetometer or support AHRS output. See Table 1 and Table 2 for specific configurations.

Each module is factory calibrated and compensated for temperature, bias, scale factor, and cross-axis errors before shipment. Data communication is provided through a Type-C interface with an onboard USB-to-UART bridge. The accompanying GUI software is used for configuration, data visualization, firmware upgrade, and data logging during evaluation.



Figure 2: GUI Software

Contents

- 1 Features 1
 - 1.1 Hardware 1
 - 1.2 Software 1
- 2 Applications 1
- 3 Description 2
 - 3.1 System Block Diagram 2
 - 3.2 General Description 2
- 4 Product Selection 5
- 5 Ordering Information 6
 - 5.1 Ordering Code 6
 - 5.2 Contact Information 6
- 6 Document Information 7
 - 6.1 Revision History 7
 - 6.2 Related Documents 7
- 7 HI13 System Architecture 8
 - 7.1 IMU 8
 - 7.2 VRU 8
 - 7.3 AHRS 8
- 8 Interface 9
- 9 Sensor Performance Specifications 10
 - 9.1 Gyroscope 10
 - 9.2 Accelerometer 13
 - 9.3 Magnetometer 15
 - 9.4 Barometer Specifications 15
 - 9.5 Temperature Sensor Specifications 15
 - 9.6 Fusion Accuracy 15
- 10 System and Electrical Specifications 16
 - 10.1 Electrical Specifications 16
 - 10.2 Interface Specifications 16
 - 10.3 System Specifications 16
 - 10.4 Absolute Maximum Ratings 16
- 11 Mechanical Dimensions 17
- 12 Coordinate System 18
 - 12.1 ENU (Default) 18
 - 12.2 NWU and NED 18
- 13 Installation 19

HI13 Series Datasheet

General-Purpose IMU/VRU/AHRS Module

REV: 1.5

14 Cable	20
15 Communication Protocol	21
16 Disclaimer	22

4 Product Selection

Table 1: Selection Information

HI13a-b-c							
Identifier	Series	a - Sensor Configuration		b - Data Interface		c - Other Information	
		M0	IMU/VRU			000	Default
		M3	IMU/VRU/AHRS			Other	Custom
		R2	IMU/VRU				
HI	13	R3	IMU/VRU/AHRS	USB	UART to USB		
		S2	IMU/VRU				
		S3	IMU/VRU/AHRS				
		S4	IMU/VRU/AHRS + Barometer				

Note 1: For current standard models, refer to the Ordering Information section. Other models are available upon request.

Note 2: Hereinafter, HI13MX refers to the M0/M3 series, HI13RX refers to the R2/R3 series, and HI13SX refers to the S2/S3/S4 series.

Table 2: HI13 Series Module Configuration

Model	3-Axis Accelerometer	3-Axis Gyroscope	3-Axis Magnetometer	Barometer
HI13M0-USB	√	√	×	×
HI13M3-USB	√	√	√	×
HI13R2-USB	√	√	×	×
HI13R3-USB	√	√	√	×
HI13S2-USB	√	√	×	×
HI13S3-USB	√	√	√	×
HI13S4-USB	√	√	√	√

5 Ordering Information

5.1 Ordering Code

Table 3: Ordering Code

Part Number	Name	Description	Note
HI13M0-USB-000	IMU/VRU Module	IMU/VRU module	
HI13M3-USB-000	IMU/VRU/AHRS Module	IMU/VRU/AHRS module	
HI13R2-USB-000	IMU/VRU Module	IMU/VRU module	
HI13R3-USB-000	IMU/VRU/AHRS Module	IMU/VRU/AHRS module	
HI13S2-USB-000	IMU/VRU Module	Low-noise IMU/VRU module	
HI13S3-USB-000	IMU/VRU/AHRS Module	Low-noise IMU/VRU/AHRS module	
HI13S4-USB-000	IMU/VRU/AHRS Module	Low-noise IMU/VRU/AHRS module with integrated barometer	

5.2 Contact Information

1. Email: overseas1@hipnuc.com
2. Website: www.hipnuc.com

6 Document Information

6.1 Revision History

Table 4: Revision History

Revision	Date	Author	Changes
1.0	May 23, 2023	Hipnuc	Initial release
1.1	Sep 13, 2023	Hipnuc	Added description of the bottom board-to-board connector
1.2	Dec 1, 2024	Hipnuc	Updated P/N and removed the board-to-board connector model
1.3	Mar 17, 2025	Hipnuc	Updated Allan parameters
1.4	Jun 17, 2025	Hipnuc	Added HI13SX Series
1.5	Mar 8, 2026	Hipnuc	Corrected specifications and revised document layout

6.2 Related Documents

1. Command and Programming Manual
2. STEP file
3. Compliance documents such as RoHS/CE
4. GUI software and reference examples

7 HI13 System Architecture

The HI13 Series is a family of sensor modules supporting IMU, VRU, and AHRS configurations. Depending on the model, it provides raw sensor data such as acceleration, angular rate, and magnetic field, as well as computed attitude outputs including Euler angles and quaternions. All modules are factory calibrated and compensated for scale factor, cross-axis alignment, temperature, and bias before shipment.

Depending on the model configuration, the HI13 module may integrate a 3-axis accelerometer, 3-axis gyroscope, 3-axis magnetometer, barometer, and a high-performance processor. This controller is primarily used for sensor synchronization, calibration, algorithm fusion, and user configuration. Additionally, based on application scenarios and sensor characteristics, the module supports multiple operating modes, including 6-DoF mode, AHRS mode, and humanoid-robot mode. For details, please refer to the Command and Programming Manual.

7.1 IMU

The HI13 can be used as an Inertial Measurement Unit (IMU), providing high-precision 3-axis acceleration and 3-axis angular rate data. Collected by the integrated high-precision accelerometer and gyroscope, these data reflect the real-time motion state and dynamic behavior of an object in 3D space. Compared with uncompensated inertial sensor devices, the HI13 provides the advantage of factory-completed system-level calibration and compensation, including cross-axis alignment, scale factor, bias, and temperature compensation, which significantly improves output accuracy and consistency.

7.2 VRU

Through sensor fusion, the HI13 outputs gravity-referenced attitude information, primarily including pitch and roll. In 6-DoF mode, it can also provide an estimated yaw angle; however, this value will accumulate drift over time.

7.3 AHRS

Based on the IMU and VRU functions, the HI13 is further upgraded to a more powerful Attitude and Heading Reference System (AHRS) by integrating a high-precision, wide-range TMR (Tunneling Magnetoresistance) geomagnetic sensor. This upgrade significantly enhances the attitude sensing capability of the HI13, enabling it to provide users with more comprehensive and accurate attitude data, including long-term stable pitch, roll, and yaw referenced to magnetic north.

8 Interface

The HI13 Series communicates through a USB-to-UART interface. By default, the communication frame format is the standard 8N1 configuration, namely:

- Baud rate: 115200 bps (adjustable as needed)
- Data bits: 8
- Parity: None
- Stop bits: 1

This standard 8N1 UART configuration provides broad compatibility with embedded systems, industrial controllers, and robotic platforms.

Note 1: Both baud rate and data output rate can be changed through commands. For details, refer to the Command and Programming Manual.

9 Sensor Performance Specifications

9.1 Gyroscope

Table 5: Gyroscope Specifications

Parameter	Product	Condition	Min	Typ	Max	Unit	Note	
Range	HI13MX/HI13RX			±250				
				±500				
				±1000				
				±2000				
				±250		°/s	Default: ±2000	
		HI13SX			±500			
				±1000				
				±2000				
				±4000				
Resolution	HI13MX/HI13RX			16		bit		
	HI13SX				20			
Scale Factor Error	HI13MX/HI13RX	100 °/s		<600	850	ppm	Typ: RMS	
	HI13SX				1200			
Nonlinearity				±0.05		%FS	1	
Noise Density	HI13MX	Bandwidth 47 Hz		0.014				
	HI13RX	Bandwidth 47 Hz		0.008		°/s/√Hz		
	HI13SX	Bandwidth 10 Hz		0.0025				
3 dB Bandwidth	HI13MX/HI13RX			80	200	Hz	2	
	HI13SX			80	400			
Zero-Rate Output				<0.1	±0.45	°/s	3	
Sampling Rate				1000		Hz		
Bias Instability Allan Variance	HI13MX	X		2.5	4			
		Y		3.2	5.5			
		Z		3	5.5			
	HI13RX	X		1.5	2.5		°/h	Typ: 1σ
		Y		1.9	3.2			Max: 3σ
		Z		1.7	3.2			
	HI13SX	X		4	6			
		Y		1.5	2.5			
		Z		1.7	4			
Bias Stability 10 s averaging	HI13MX	X		10	14			
		Y		13	17			
		Z		10	13			
	HI13RX	X		5.5	7		°/h	Typ: 1σ
		Y		7.5	9			Max: 3σ
		Z		5.5	7			
	HI13SX	X		10	16			
		Y		4	7			
		Z		5	13			

Bias Repeatability	HI13MX	X	20	36	%h	
		Y	36	61		
		Z	16	25		
	HI13RX	X	11.5	21		
		Y	15	30		
		Z	9.5	15		
	HI13SX	X	11	35		
		Y	10	30		
		Z	9	20		
Angle Random Walk Allan Variance	HI13MX	X	0.55	1.1	%√h	Typ: 1σ Max: 3σ
		Y	0.82	1.2		
		Z	0.47	0.7		
	HI13RX	X	0.3	0.6		
		Y	0.4	0.7		
		Z	0.2	0.4		
	HI13SX	X	0.12	0.16		
		Y	0.1	0.12		
		Z	0.1	0.14		
Bias Variation Over Temperature		-40 °C to 85 °C	0.07	0.15	%/s	4
g - Sensitivity		All three axes	0.05		%/s/g	

- Note 1:** Maximum deviation from the best-fit straight line within the specified range.
- Note 2:** Different modes have different bandwidths; the default 6-DoF mode bandwidth is 80 Hz.
- Note 3:** After initial bias calibration, the bias can be estimated in real time by the algorithm engine.
- Note 4:** Measured using a thermal chamber and rate table in the Hipnuc laboratory, with a temperature ramp rate of less than 3 °C/min.

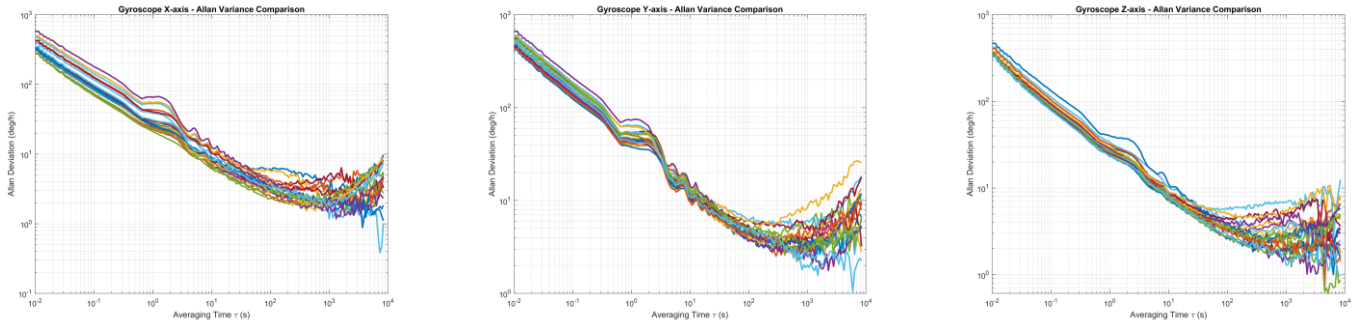

Figure 3: HI13MX Gyroscope Allan Variance

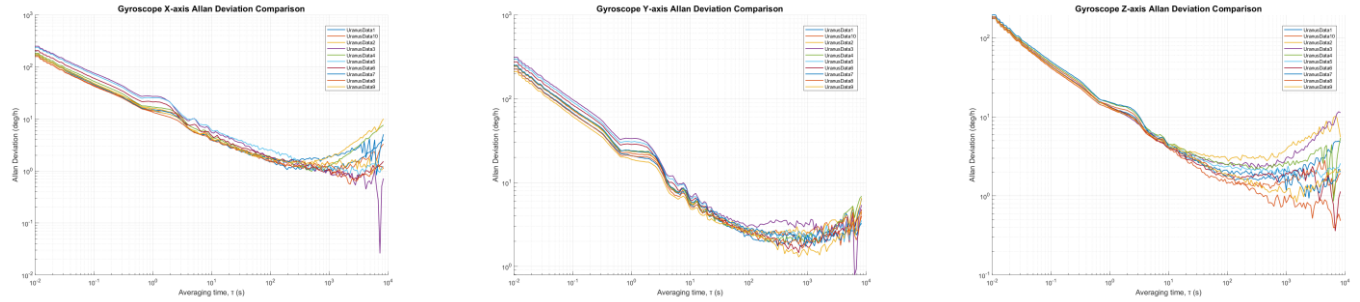

Figure 4: HI13RX Gyroscope Allan Variance

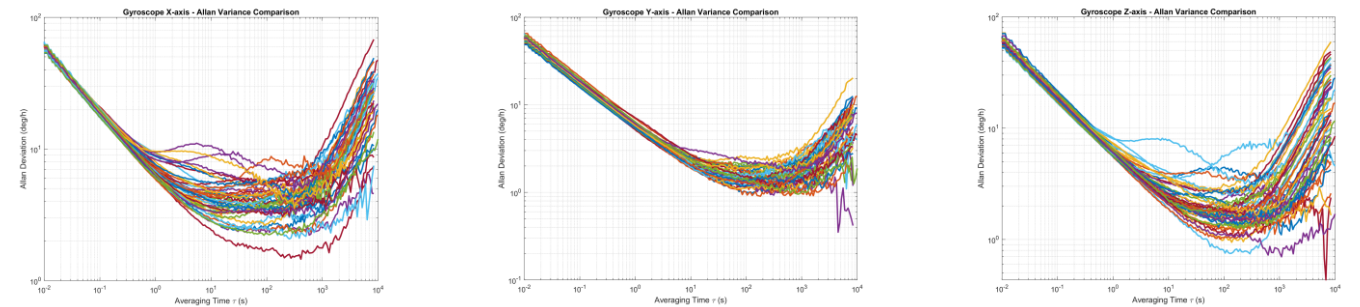

Figure 5: HI13SX Gyroscope Allan Variance

9.2 Accelerometer

Table 6: Accelerometer Specifications

Parameter	Product	Condition	Min	Typ	Max	Unit	Note
Range	HI13MX/HI13RX			±3		g	Default: ±12
				±6			
				±12			
				±24			
	HI13SX			±2		g	Default: ±16
				±8			
			±16				
			±32				
Resolution	HI13MX/HI13RX			16		bit	
	HI13SX			16	20		
Initial Bias				1	2	mg	Typ: RMS
Nonlinearity	HI13MX/HI13RX			±0.5		%FS	1
	HI13SX			±0.01			
Noise Density	HI13MX			0.16	0.2	mg/√Hz	
	HI13RX			0.1	0.12		
	HI13SX	Bandwidth 10 Hz		0.05	0.07		
3 dB Bandwidth	HI13MX/HI13RX			90	200	Hz	2
	HI13SX			90	400		
Sampling Rate				1000		Hz	
Bias Instability Allan Variance	HI13MX	X		0.021	0.035	mg	Typ: 1σ Max: 3σ
		Y		0.032	0.065		
		Z		0.023	0.03		
	HI13RX	X		0.015	0.02	mg	
		Y		0.02	0.045		
		Z		0.015	0.02		
	HI13SX	X		0.012	0.02	mg	
		Y		0.009	0.015		
		Z		0.016	0.022		
Bias Stability 10 s averaging	HI13MX	X		0.068	0.1	mg	Typ: 1σ Max: 3σ
		Y		0.09	0.19		
		Z		0.07	0.1		
	HI13RX	X		0.06	0.1	mg	
		Y		0.055	0.15		
		Z		0.05	0.06		
HI13SX	X		0.032	0.055	mg		
	Y		0.022	0.032			
	Z		0.048	0.082			
Bias Repeatability	HI13MX	X		0.22	0.4	mg	
		Y		0.15	0.21		
		Z		0.12	0.2		

HI13 Series Datasheet

General-Purpose IMU/VRU/AHRS Module

REV: 1.5

Bias Repeatability	HI13RX	X	0.127	0.25	mg	
		Y	0.09	0.15		
		Z	0.07	0.15		
Bias Repeatability	HI13SX	X	0.1	0.3	mg	
		Y	0.06	0.2		
		Z	0.1	0.2		
Velocity Random Walk	HI13MX	XYZ	0.09	0.11	m/s/√h	Typ: 1σ Max: 3σ
Allan Variance	HI13RX	XYZ	0.055	0.065		
	HI13SX	XYZ	0.019	0.03		
Bias Variation Over Temperature	HI13MX/HI13RX	XYZ	2	5	mg	3
-40 °C to 85 °C	HI13SX	XY	2	5		
		Z	6	15		

Note 1: Maximum deviation from the best-fit straight line within the specified range.

Note 2: Different modes have different bandwidths; the default 6-DoF mode bandwidth is 90 Hz.

Note 3: Measured using a thermal chamber and rate table in the Hipnuc laboratory, with a temperature ramp rate of less than 3 °C/min.

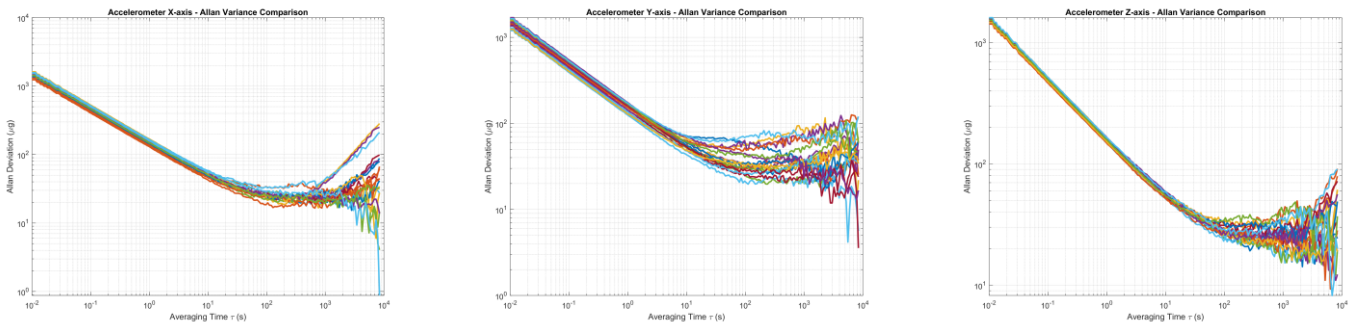

Figure 6: HI13MX Accelerometer Allan Variance

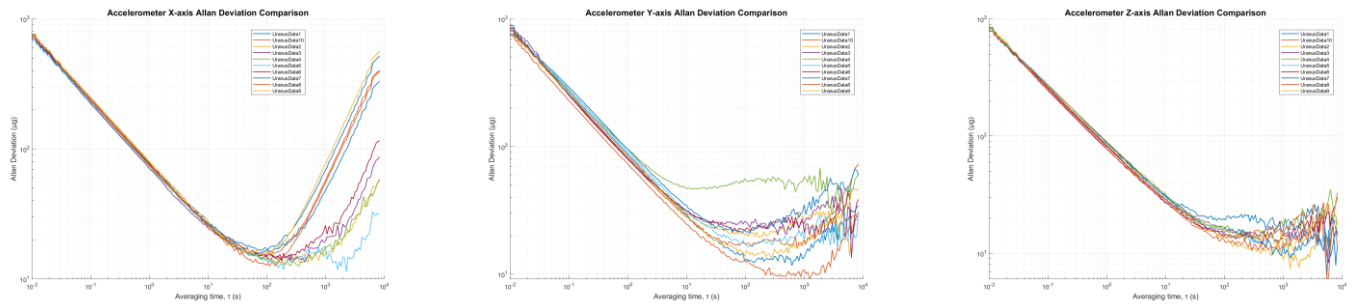

Figure 7: HI13RX Accelerometer Allan Variance

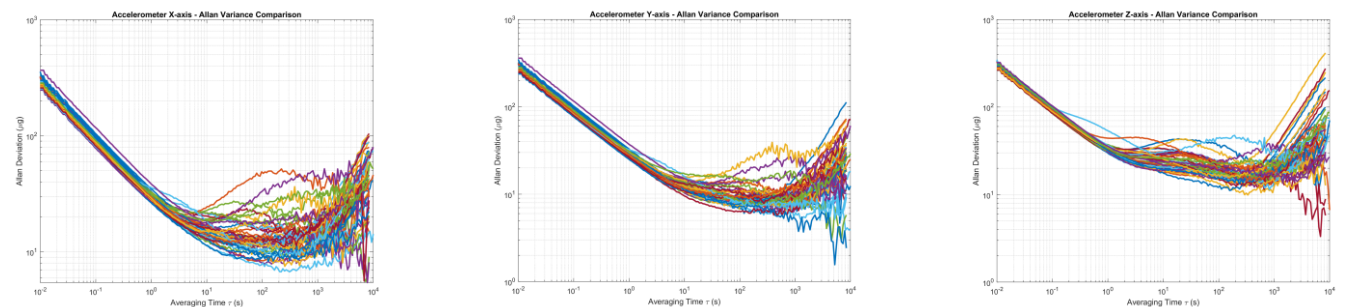

Figure 8: HI13SX Accelerometer Allan Variance

9.3 Magnetometer

Table 7: Magnetometer Specifications

Parameter	Condition	Min	Typ	Max	Unit	Note
Range			±2000		μT	
Noise		0.19	0.45		μT	
Nonlinearity		±10	±20		μT	

9.4 Barometer Specifications

Table 8: Barometer Specifications

Parameter	Condition	Min	Typ	Max	Unit	Note
Range		300	-	1200	hPa	
Resolution			0.006		hPa	
Accuracy			±0.06		hPa	

9.5 Temperature Sensor Specifications

Table 9: Temperature Sensor Specifications

Parameter	Condition	Min	Typ	Max	Unit	Note
Range		-40	-	85	°C	
Offset Error			±5		°C	

9.6 Fusion Accuracy

Unless otherwise specified, the following attitude accuracy values are measured after factory calibration under typical installation conditions. Actual performance depends on installation flatness, mechanical stress, vibration, linear acceleration, magnetic environment, and user calibration status.

Table 10: Attitude Accuracy

Parameter	Product	Condition	Min	Typ	Max	Unit	Note
Pitch/Roll (Static)				0.1	0.15	°	1
Pitch/Roll (Dynamic)				0.2	0.3	°	
Heading Accuracy (AHRS)				2	3	°	2
Static Heading Drift (6-DoF)		Static for 2 h		0.15	0.2	°	
Dynamic Heading Drift (6-DoF)	HI13MX			±10	±18	°	3
	HI13RX/SX			±5	±10	°	
Heading Rotation Error (6-DoF)	HI13MX/RX	100 °/s rotation		0.2	0.3	°	4
	HI13SX			0.2	0.4	°	

Note 1: Data are referenced to the calibration plane and derived from tests on 20 samples.

Note 2: Measured after geomagnetic calibration in a magnetically undisturbed environment. The product must be configured in AHRS mode.

Note 3: Measured over 1 hour of operation on an indoor cleaning robot platform; results are given as 1σ. In 6-DoF mode, heading is an estimated value without magnetic reference. Its long-term stability is affected by initial alignment, motion conditions, environmental conditions, and time.

Note 4: Average error per revolution when the module rotates 10 cycles on a turntable.

10 System and Electrical Specifications

10.1 Electrical Specifications

Table 11: Electrical Specifications

Parameter	Product	Min	Typ	Max	Unit	Note
Operating voltage range, VDD		4.5	5	5.5	V	
Power Consumption	HI13MX			215	mW	
	HI13RX/HI13SX			300		

10.2 Interface Specifications

Table 12: Interface Specifications

Port	Parameter	Min	Typ	Max	Unit	Note
USB	Baud Rate	9600	115200	921600	bps	
	Output Data Rate	0	100	1000	Hz	

Note 1: Baud rate and output data rate are both configurable. The actual available output data rate depends on the output data content, packet length, and communication configuration. Refer to the Command and Programming Manual for details.

10.3 System Specifications

Table 13: System Specifications

Parameter	Value	Note
Dimensions	26 × 24 × 12 mm	
Weight	<11 g	
System Start-up Time	2 s	1
Operating Temperature	-40 °C to 85 °C	
Shield Material	Aluminum alloy	
Vibration Resistance	1.0 mm (10 Hz-58 Hz) / ≤20 g (58 Hz-600 Hz)	
Environmental Compliance	Complies with relevant RoHS requirements, Halogen-free materials	
Compliance Information	Related certifications and declarations of conformity are subject to the latest official information	
Drop Test	Free fall from a laboratory bench height of 75 cm, repeated 3 times	
Temperature Shock Test	Temperature cycled from -40 °C to 85 °C within 1 hour, repeated for 5 cycles	
Moisture Sensitivity Level (MSL)	MSL 2	

Note 1: Time from power-on to valid data output.

10.4 Absolute Maximum Ratings

Table 14: Absolute Maximum Ratings

Parameter	Limit	Comment
Mechanical Shock	10,000 g	Duration <0.2 ms
Storage Temperature	-40°C to 125°C	
ESD (HBM)	15 kV	JEDEC/ESDA JS-001
Input Voltage	5.5 V	

Note 1: Exceeding the absolute maximum ratings may cause permanent damage to the device. Functional operation at these conditions is not guaranteed.

11 Mechanical Dimensions

All dimensions are in mm

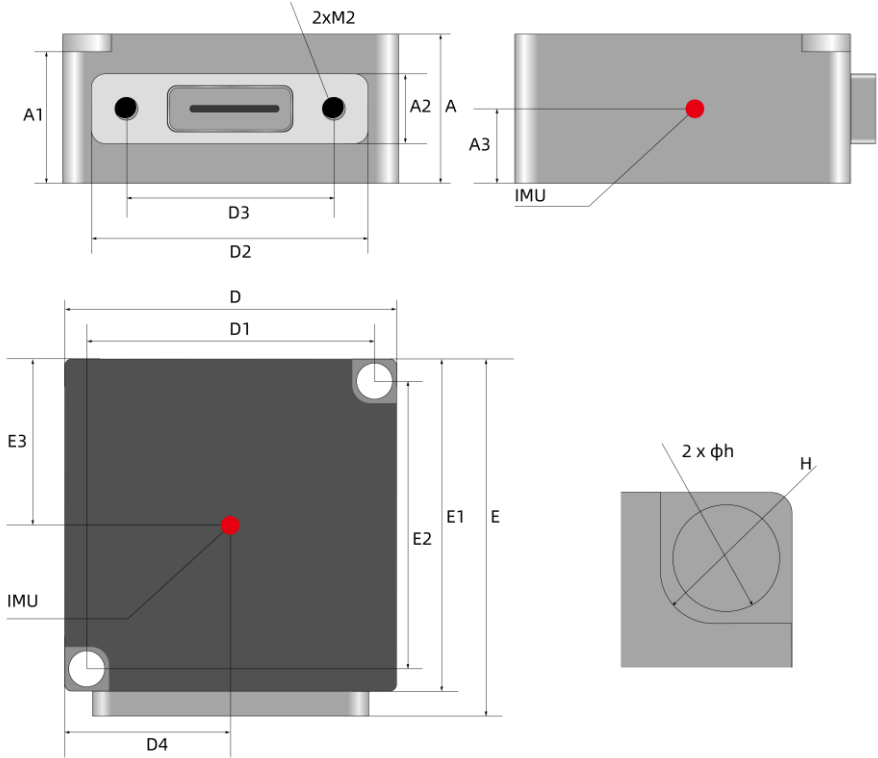

Figure 9: HI13 Mechanical Dimensions and IMU Location

Table 15: HI13 Dimensional Data

Symbol	Min (mm)	Type (mm)	Max (mm)
A	11.8	12	12.2
A1	10.2	10.4	10.6
A2	4.8	5	5.2
A3	5.8	6	6.2
D	23.8	24	24.2
D1	20	20.2	20.4
D2	19.8	20	20.2
D3	14.8	15	15.2
D4	11.8	12	12.2
E	25.8	26	26.2
E1	23.8	24	24.2
E2	20	20.2	20.4
E3	11.8	12	12.2
H	R2.25	R2.3	R2.35
h	φ2.55	φ2.6	φ2.65

12 Coordinate System

12.1 ENU (Default)

The body frame adopts the Right-Forward-Up (RFU) coordinate system, and the geodetic frame adopts the East-North-Up (ENU) coordinate system. The axes of acceleration and gyroscope are shown in the figure below:

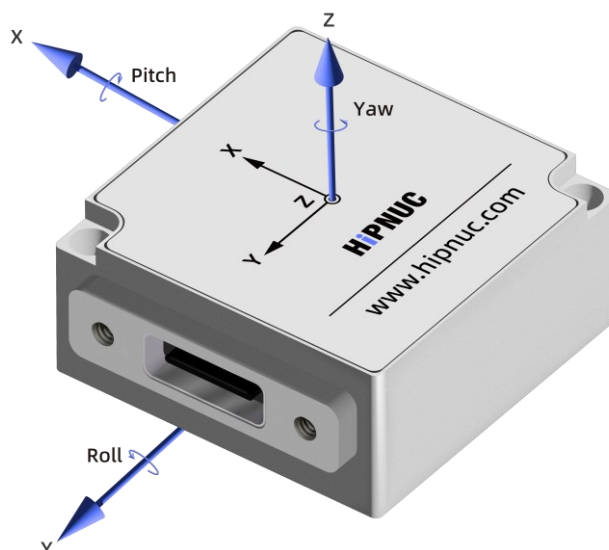

Figure 10: HI13 Coordinate System

The Euler-angle rotation sequence follows the ENU 3-1-2 convention, i.e., rotation about the Z-axis first, followed by the X-axis, and then the Y-axis. The specific definitions are as follows:

- Rotation around the Z-axis: Heading Angle (Yaw, ψ); Range: $-180^\circ - 180^\circ$
- Rotation around the X-axis: Pitch Angle (θ); Range: $-90^\circ - 90^\circ$
- Rotation around the Y-axis: Roll Angle (ϕ); Range: $-180^\circ - 180^\circ$

When the module is interpreted using an aircraft convention, the positive Y-axis corresponds to the forward direction. When the sensor frame coincides with the inertial frame, the ideal output of Euler angles is: Pitch = 0° , Roll = 0° , Yaw = 0° .

For coordinate system rotation, please refer to the Command and Programming Manual

12.2 NWU and NED

The body frame can also be configured to the North-West-Up (NWU) or North-East-Down (NED) coordinate system. Users need to configure it independently. For details, refer to the Command and Programming Manual

13 Installation

- The mounting surface should be as flat as possible and rigidly fixed.
- Avoid installing the module near high-temperature heat sources.
- Avoid continuous mechanical stress on the module caused by cable harness pulling.
- For AHRS applications, keep the module away from sources of magnetic interference such as motors, magnetic steel components, and high-current wiring.
- After final installation, magnetic calibration is recommended before use.
- For vibration-intensive applications, validation under the final system-level installation conditions is recommended.

14 Cable



Figure 11: HI13 USB A to Type-C Cable

Note 1: The cable length is 1.2 m.

15 Communication Protocol

The HI13 Series supports a configurable binary serial communication protocol. Message formats, output configuration, and command definitions are described in the Command and Programming Manual.

16 Disclaimer

The parameters provided in this document are typical values, maximum values, or measured values obtained under specified test conditions and do not constitute binding product specifications or delivery commitments. Hipnuc reserves the right to modify the product, this document, and related information without prior notice.